

Mechanical Dimensions

REV.	DESCRIPTION	DATE	DWN	APPD
2.0	Add Package	22.12.8	ZSY	ZSY
3.0	Add Mech	25.12.3	ZSY	ZSY

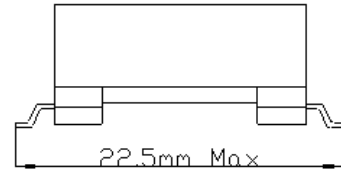
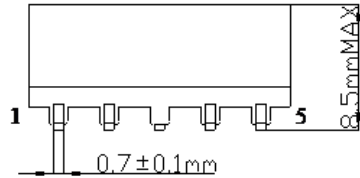
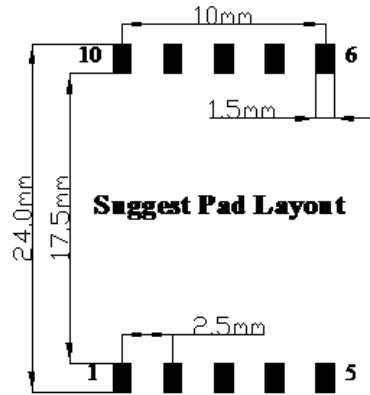
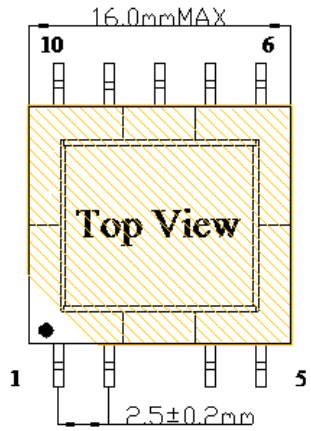

PIN 3 cut off

ELECTRICAL SPECIFICATIONS@25°C:

TurnRatio: (2-1):(4-5):(7-6):(10-9) =19:38:38:38±3%

L (100KHz/0.1V) : (2-1) 30uH±10%

LK(100KHz/0.1V) : (2-1 other pin short) 0.70uHMAX

DCR:(2-1) 0.137 Ω MAX (4-5) 2.39 Ω MAX

(10-9) 0.65 Ω MAX (7-6)2.24 Ω MAX

HI-POT:

PRI TO SEC AC3750V /3mA MAX/ 3S

Schematics

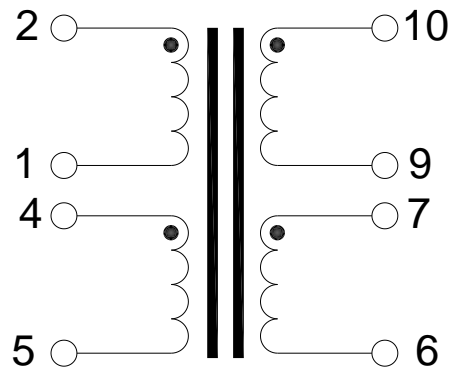

 元册科技股份有限公司 YUAN DEAN SCIENTIFIC CO., LTD.			
TITLE	TRANSFORMER		
P/N	15SEFD-3001FVNL	REV.	3.0
PAGE NO	1-2	DATE	2025.12.3
APPD	ZSY	DWN	ZSY

Package

1. Packaging Unit:

Tape & Reel-----350pcs/Reel

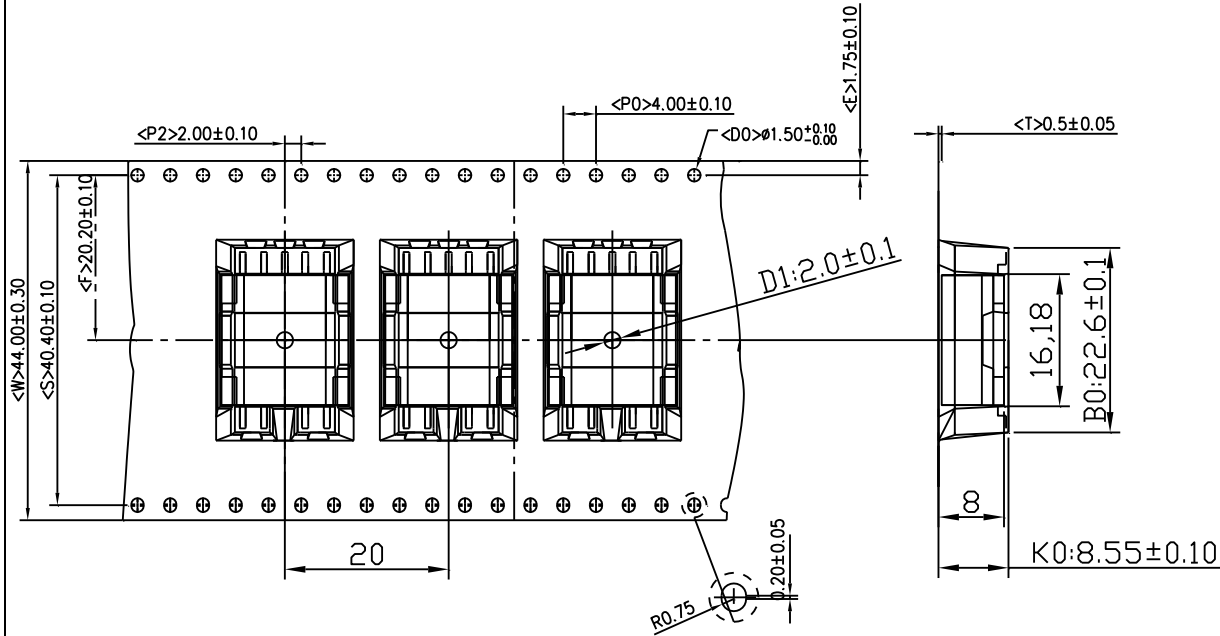

2. Carton Unit: 2100 PCS/ 6Reel/Box

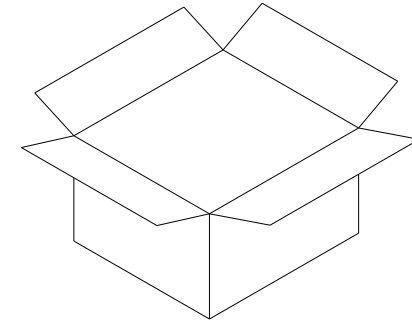
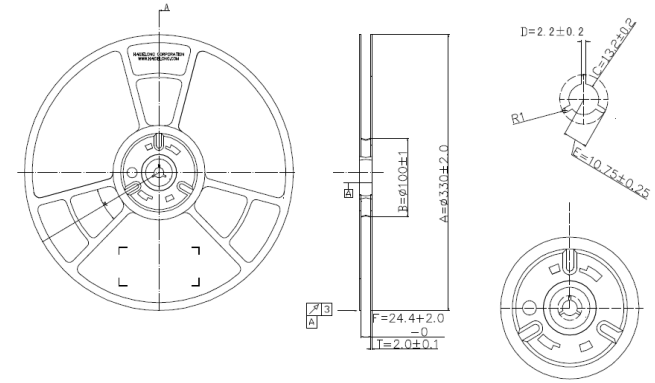

Outer carton: 365x365x350mm

(Unit:mm)



元册科技股份有限公司
YUAN DEAN SCIENTIFIC CO., LTD.

TITLE	TRANSFORMER			P/N	15SEFD-3001FVNL	DATE	2025.12.3
REV.	3.0	PAGE NO	2-2	AP'PD	ZSY	DWN	ZSY